

Article number: 01010621
 Description: Retaining ring A 45 DIN 471
 Stainless 411
 Note: Fitted with ZGA pilers

Measures

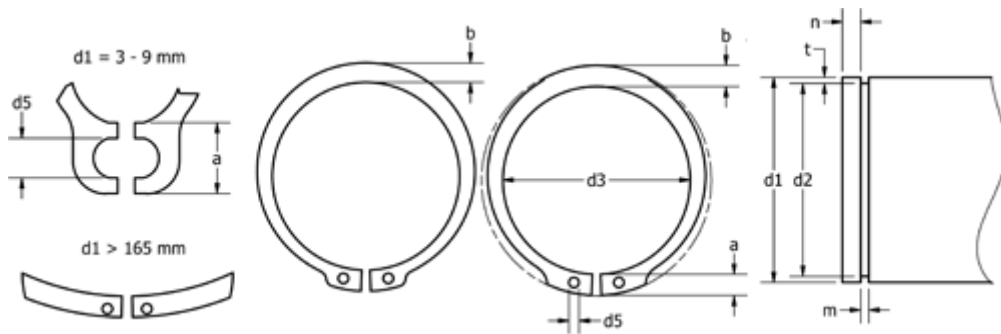

a max	= 6.7	FN kN	= 28.6	s	= 1.75
AN mm ²	= 172.0	FRg kN	= 9.35	t	= 1.25
b	= 4.7	FR kN	= 49.00	tol	= -0.25
d1	= 45	g	= 2.0	tol	= -0.06
d2	= 42.5	K kN-mm	= 91.00	tol	= +0,39-0,90
d3	= 41.5	m min	= 1.85	Tong	= ZGA-3
d5 min	= 2.5	n abl x 1000	= 11.0	Weight kg/1000	= 7.500
Description	= A45	Nominal drive	= 3.8		